



SPECIFICATION FOR APPROVAL

KTY84-150

承认书

客户名称 (CUSTOMER): _____

产品名称 (PRODUCT ITEM): KTY84/150

客户料号 (CUSTOMER PART NO.): _____

规格型号 (PART NO.): KTY84-150, KTY84/150

文件编号 (FILE NO.): _____

编制日期 (DATE): _____

客户确认 (CUSTOMER CONFIRM)	批准 (APPROVE)
	审核 (CHECK)



南京华巨电子有限公司

SinoChip (Nanjing) Electronics Co.,LTD

产品技术规格

1. 外型尺寸

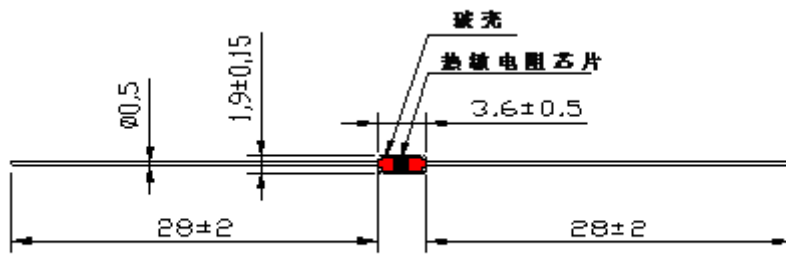
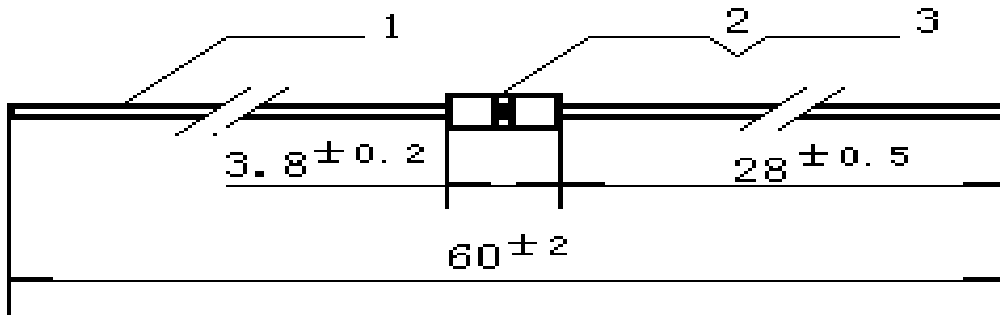

外型结构尺寸图

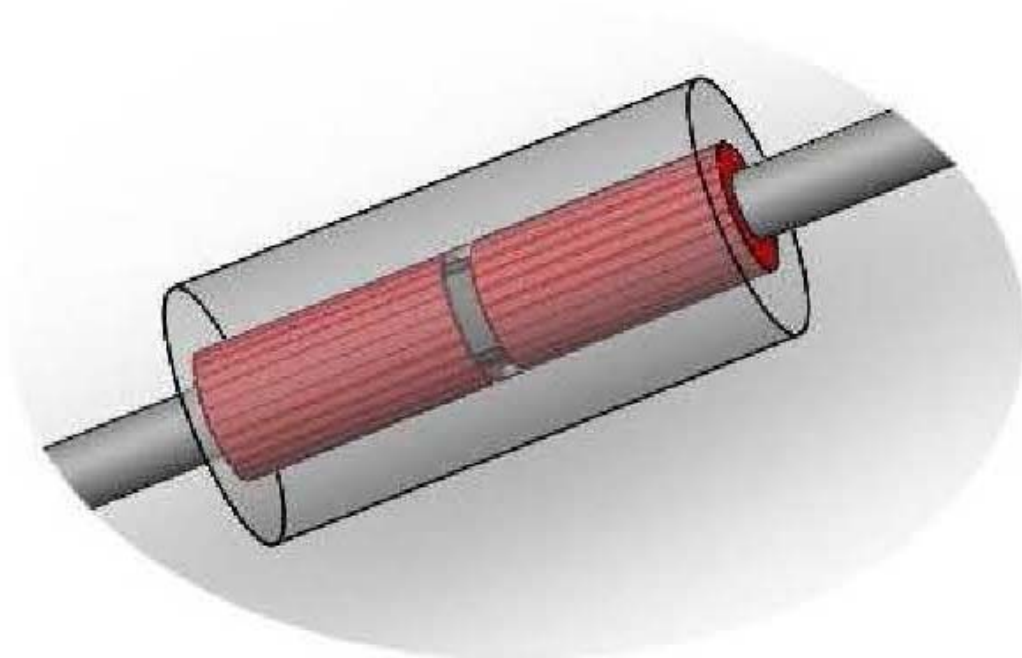

SinoChip (Nanjing) Electronics Co.,LTD

产品技术规格

序号	名称	材料规格
1	杜美丝	镍铜合金
2	芯片	$R_{100} = 950 \sim 1050$
3	玻壳	$\Phi_{外} 2.0\text{mm}_{max}, \Phi_{内} 0.8 \pm 0.05\text{mm}$

■ 电气参数

序号	电气参数	符号	测试条件	最小值	标准值	最大值	单位
1	25℃电阻值	R_{25}	恒温 $25 \pm 0.05^\circ\text{C}$	565	603	641	Ω
2	100℃电阻值	R_{100}	恒温 $100 \pm 0.05^\circ\text{C}$	950	1000	1050	Ω
3	耗散系数	δ	静止空气中	1.5	/	/	$\text{mW}/^\circ\text{C}$
4	热时间常数	τ	静止空气中	/	/	7	s
5	绝缘电阻	/	DC=100V	100	/	/	$\text{M}\Omega$
6	最大工作电流	I_{max}	/	/	/	8	mA
7	额定工作电流	I_N	/	/	5	/	mA
8	额定功率	P_{max}	/	/	/	50	mW
9	工作温度	T_A	$-40 \sim +210^\circ\text{C}$				
10	贮藏时间	T_{min}	2年（室温、相对湿度<60%）				

SinoChip (Nanjing) Electronics Co.,LTD

产品技术规格

R-T 特性参数表

摄氏度		温度系数	KTY84/150,KTY84-150,KTY84/150			
摄氏度	华氏度		(%/K)	(Ω)		
		MIN.		TYP.	MAX.	
-40	-40	0.84	332	359	386	±8.85
-30	-22	0.83	362	391	419	±8.76
-20	-4	0.82	394	424	455	±8.70
-10	14	0.8	428	460	492	±8.65
0	32	0.79	464	498	532	±8.61
10	50	0.77	503	538	574	±8.58
20	68	0.75	544	581	618	±8.55
25	77	0.74	565	603	641	±8.54
30	88	0.73	587	626	665	±8.53
40	104	0.71	632	672	713	±8.50
50	122	0.7	679	722	764	±8.46
60	140	0.68	729	773	817	±8.42
70	158	0.66	781	826	872	±8.37
80	176	0.64	835	882	929	±8.31
90	194	0.63	891	940	989	±8.25
100	212	0.61	950	1000	1050	±8.17
110	230	0.6	1007	1062	1117	±8.66
120	248	0.58	1067	1127	1187	±9.17
130	266	0.57	1128	1194	1259	±9.69
140	284	0.55	1191	1262	1334	±10.24
150	302	0.54	1256	1334	1412	±10.80
160	320	0.53	1322	1407	1492	±11.37
170	338	0.52	1391	1482	1574	±11.96
180	356	0.51	1461	1560	1659	±12.58
190	374	0.49	1533	1640	1747	±13.20
200	392	0.48	1607	1722	1837	±13.85
210	410	0.47	1683	1807	1931	±14.51

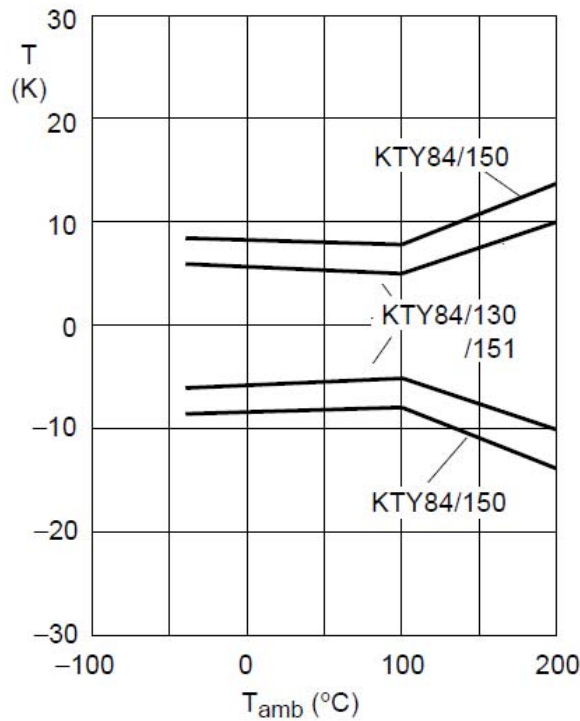
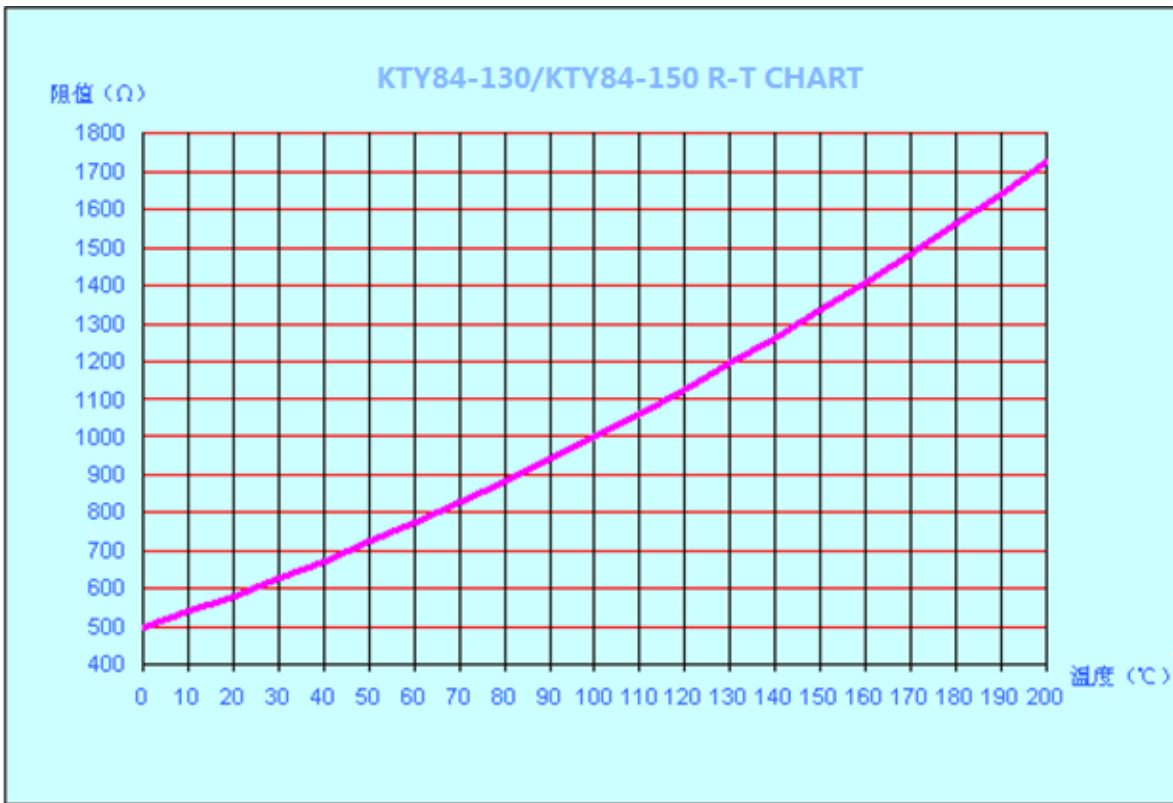

Fig 1. Maximum expected temperature error (ΔT)

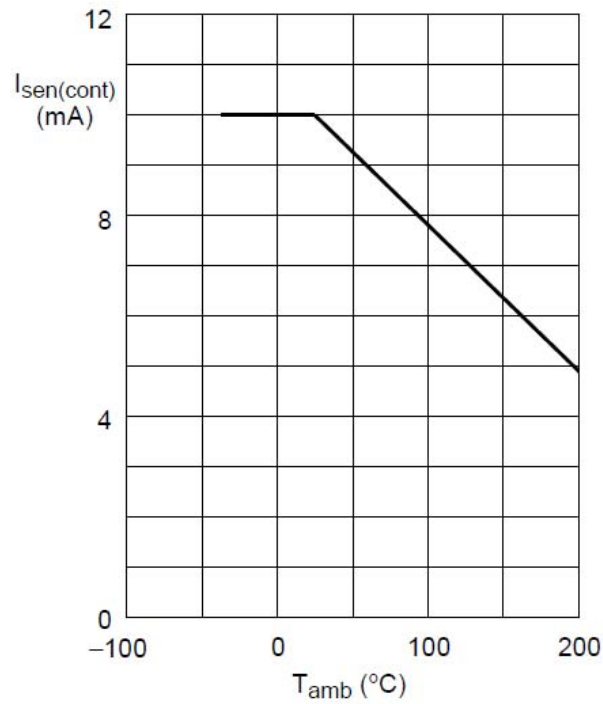
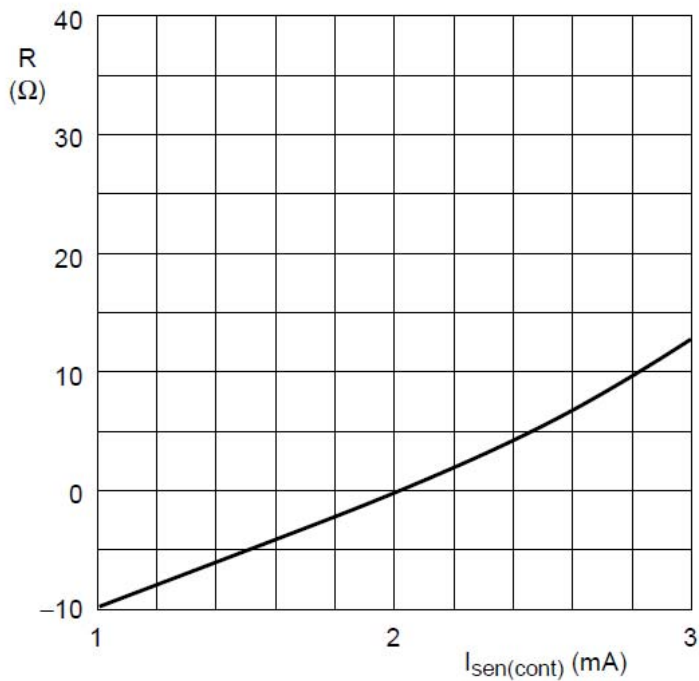

Fig 2. Maximum operating current for safe operation



$T_{amb} = 100\text{ }^{\circ}\text{C}$

Fig 3. Deviation of sensor resistance as a function of operating current in still liquid